

Worcester Classic Spares

Unit K, Broomhall Business Centre, Broomhall Lane, Worcester, WR5 2NT

www.worcesterclassicspares.com

info@worcesterclassicspares.com



Mk 5

Parts List

01905
821569

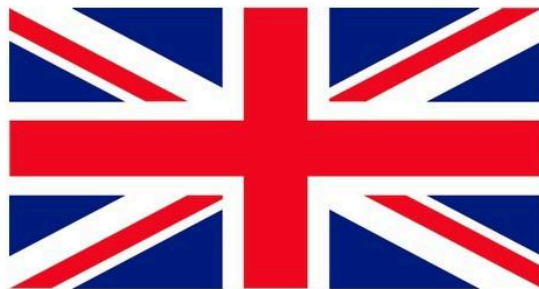

Open
Monday -Friday
1pm - 5pm

Dear Customer,

This price list outlines all the parts we can supply for the Jaguar Mk 5. These parts are mostly new reproduction. We try to hold as many parts in stock as possible, but some items are bought to order. If there is an item you require that is not listed, please let us know and we will make every effort to locate it for you and may be able to supply a used original part from our large selection.

Orders can be placed by WhatsApp, email or over the phone, when ordering please state our reference numbers (which appear on the far left of the page) and **provide details of your car – the make, year, chassis and engine numbers, body style and whether it is right or left hand drive**. If you are aware that the car has been modified or fitted with non-original parts please let us know as, unless notified, we will assume it is as original.

PRICES

The prices quoted are **per item** unless otherwise stated and are all in GBP. Whilst every effort will be made to adhere to the prices shown, we do reserve the right to make changes if necessary without prior notice. Any such change will be made known to the customer before sending out the order.

Please note the prices shown DO NOT include VAT - this will be added to orders for UK customers.

Payment can be made by debit or credit card (we are licensed to accept Visa and MasterCard) or by bank transfer. We also accept Paypal for orders of £100 or less.

SHIPPING/POSTAGE

Parts can be shipped to any part of the world using post or carriers on a door-to-door service - please see our terms and conditions. For small UK orders we used a tracked Royal Mail service. For larger UK orders, and all shipments going abroad, we use a variety of couriers using the company World Options.

Please note customers from the EU (and other countries) will need to pay customs/import duties when their parcel arrives in their own country. We are not involved in this - the courier should send the appropriate information and links via email.

WEBSITE

There are photos of most of the parts in this price list on our website, along with limited quantity items and Jaguar literature. We also have an expanding original parts section, the history of the company, photos of customer's cars from around the world and a restoration blog. New suggestions/contributions to our website are warmly welcomed. We are also on Facebook, see the **Mk 5 Community Group**.

STAFFING

WCS continues to be a family run business. Michael has now 'semi-retired' and works for the business on three days a week - Wednesday to Friday. I continue to be in the office from 1pm to 5pm each weekday (I have another job as a primary school teacher in the mornings!). If you have a technical enquiry that needs Michael's expertise, please ring the office and ask for a call back.

Anna Whitworth

CHROME FITTINGS

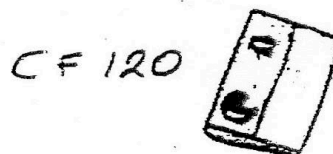
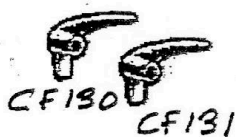
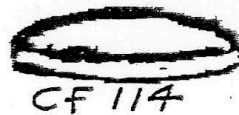
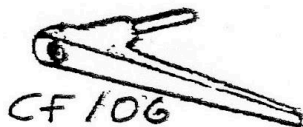
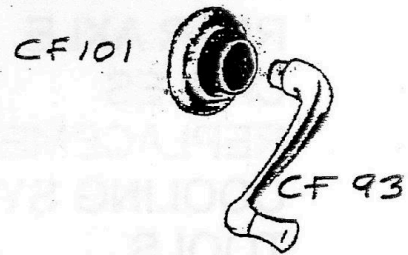
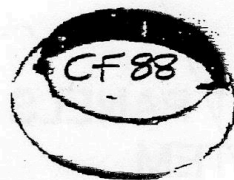
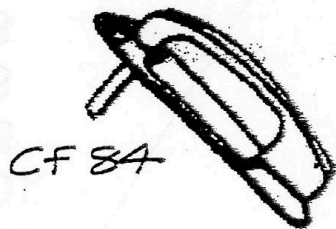
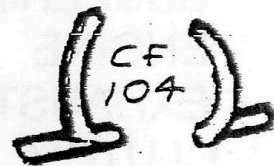
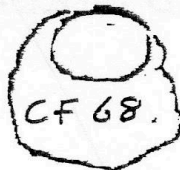
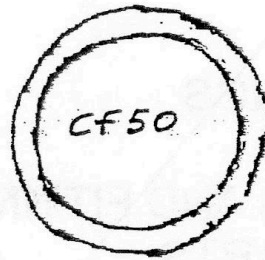
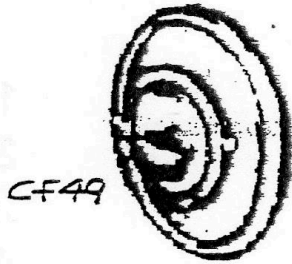
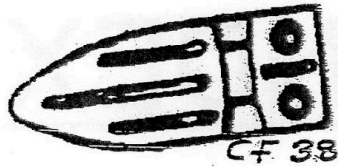
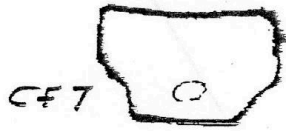

CHROME FITTINGS



CF. 7	5299/3462	BOTTOM MOTIF - HEADLAMP RIM	£23.25
CF. 27	Bd.573	HINGE for cubbybox lid on dashboard - unused original - fitted to <u>saloon cars only</u> , Chassis Nos. 520001 - 520282 and 527001 - 527073 (2.5L), 620001 - 621101 and 627001 - 627410 (3.5L)	£16.50 pair
CF. 37	BD.2561	HEADLAMP SPEAR	£28.50
CF. 38	BD.109	HINGE for toolbox - 3 per car	£41.30 each
CF. 39	BD.6206	LEAPING JAGUAR MASCOT	£124.75
CF. 49	C.3243	HUB CAP - chrome (original was part chrome and part paint)	£29.95
CF. 50	C.8385	WHEEL TRIM - polished stainless steel (clips not supplied)	£45.00
CF. 51	C.3367	HUB CAP BADGE with black background as original	£15.45
CF. 59	"572098"	CHROME SURROUND FOR BRAKE LIGHT	£19.50
CF. 61		BONNET CENTRE HINGE LENGTH: 1365MM/53"	£92.20
CF. 68	Part of BD.2883	ESCUTCHEON for petrol flap lock	£25.10
CF. 72	5294	SCREW securing headlamp rim	£2.80
CF. 80	BD.2188	HANDLE OPERATING SUNROOF	£45.10
CF. 84	BD.603	BOOT HANDLE AND ESCUTCHEON - lock barrel <u>not</u> included as standard, but available as a Special Order item for an additional charge.	£141
CF. 88	2883	CHROME SURROUND for horn push assembly	£51.75
CF. 93	BD.2233	HANDLE FOR WINDOW REGULATORS - saloon and coupe	£58.60

CF. 99	BD.1978/1979	BULKHEAD TRIM	£112.75 pair
CF. 101	BD.552/1	SPRING-LOADED ESCUTCHEON for window regulator - saloon and coupe	£19.95
CF.104	BD.2153/2154	MOULDING at left and right side of spare wheel door - sold as pair - not available individually	£135.72 pair
CF.106	BD.4057/4058	EXTERIOR DOOR HANDLE - coupe - lock barrel and key <u>not</u> included - See BF.87	£86.90
CF.108	BD.72	LUGGAGE STRAP BRACKET/STAPLE - 4 per car	£41.50
CF.113	252	RADIATOR CAP (brass) + sealing ring - drilled to take leaping Jaguar mascot	£92.50
CF.114	252	RADIATOR CAP (brass) + sealing ring - not drilled for mascot	£92.50
CF.117	C.341	DOME NUT on cylinder head - 3.5 7 per car	£8.05 each
CF.118	C.580	DOME NUT on cylinder head - 2.5L 12 per car	£8.05 each
CF.119	C.412	DOME NUT on rocker cover - 2.5/3.5L 3 per car	£5.30 each
CF.120	BD.3991	STRIKER PLATE for 1/4-light handle - Chassis Nos. 520631 – 520639, 520641 onwards and 527121 onwards (2.5L), 622291 onwards, 627727 onwards, 627702, 627703, 627706, 627717, 627722 and 627725 (3.5L)	£15.45
CF.124	BD.3991	SCREW for original sidelight (where applicable) - normally fitted only to cars originally exported to Canada and USA	£4.55 pair
CF.126	BD.6	INTERIOR DOOR HANDLE - coupe only	£61.50
CF.130	BD.3981	HANDLE locking front 1/4-light/no draught ventilator - left side (Chassis numbers as at CF.120 above)	£19.40
CF.131	BD.3982	HANDLE locking front 1/4-light/no draught ventilator - right side (Chassis numbers as at CF.120 above)	£19.40
CF.138	2312	ROUND ESCUTCHEON - spare wheel compartment lock	£16.00
CF.139	BD.2551	TEARDROP ESCUTCHEON - rear wheel spat	£15.50
CF.140	BD.2507/2508	REAR QUARTER MOULDING - DHC	£228.25 pair
CF.141		KEY PIN through quarter light handle	£0.90
CF.150	2310/1	DOVE-TAIL STRIKER for door lock. DHC - state left or right	£90.10
CF.151	BD.1977	DOOR PILLAR TRIM	£20.65
CF.152		TOP MOTIF - HEADLAMP RIM	£23.25
CF.160	BD.2190	TUBULAR SCREW – securing sunroof handle	£12.35
CF.161	BD.1971 BD.1972	REAR QUARTER MOULDINGS - saloon	£99.50 pair
CF163	BD2240	EXTERIOR DOOR HANDLE - rear left	£117.20
CF164	BD2241	EXTERIOR DOOR HANDLE - rear right	£117.20
CF165	BD2224	EXTERIOR DOOR HANDLE - front left	£117.20
CF166	BD2225	EXTERIOR DOOR HANDLE - front right	£117.20

BODY FITTINGS

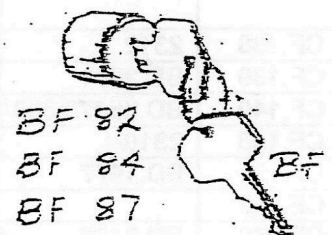
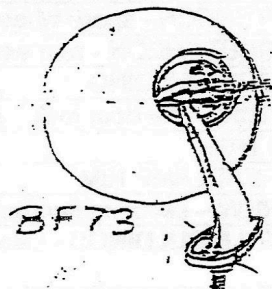
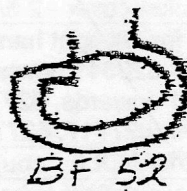
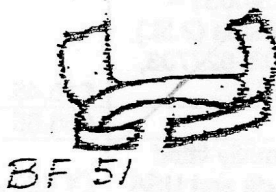
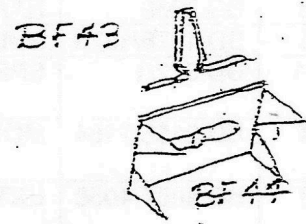
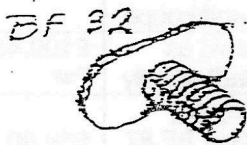
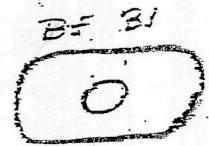
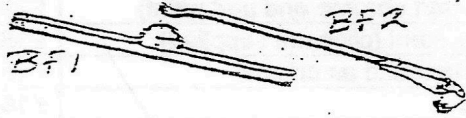

BODY FITTINGS

BF. 1	3562	WINDSCREEN WIPER BLADE	£21.50 each
BF. 2	3556	WINDSCREEN WIPER ARM	£31.25 each
BF. 3	BD4076	STUD FASTENER FOR HOOD STRAPS (metal thread) DHC only. 2 per car Also fits E-Type set 1, 1.5 & 2 DHC	£7.00 pair
BF. 6	C.4691	RED 'TELL-TALE' INDICATOR	£8.95
BF. 7	C.4098/2	CLIP for 'tell-tale' indicator	£1.35
BF. 29	C.2670	TRIANGULAR BRACKET for mounting windscreen wiper motor	£25.30
BF. 31	BD.542/3	OVAL WASHER - 1/4" hole (31 per car)	£0.45
BF. 32	BD.125	SPECIAL T-BOLT and fixings securing chrome moulding at top of outer door panel. Saloon- 12 per car Coupe - 10 per car	£1.35 each
BF. 36		HORN PUSH New, reproduction plastic dome	£160
BF. 43	BD.3030	CLIP securing interior trim to door - saloon	£0.40
BF. 44	BD.2702	PLATE retaining above clip - saloon	£0.70
BF. 51	BD.8071	SPRING CLIP securing petrol filler lock to filler door	£7.75
BF. 60	BD.212 BD.2248	SPECIAL T-BOLT + nut and 2 washers - securing chrome mouldings to bonnet - 16 per car - and centre step-beads to front wings - 14 per car	£2.10 each
BF. 64	1524	FRONT SUPPORT (brass) for bonnet hinge	£16.70
BF. 65	BD.1953	REAR SUPPORT (brass) for bonnet hinge	£16.70
BF. 68	C.3727	PETROL PIPE CLIP - as original 8 per car	£5.80 each
BF. 70	C.3529	BRAKE PIPE CLIP - as original 10 per car	£5.80 each
BF. 73	C.9091/9092	EXTERIOR/REAR VIEW MIRROR	£75 pair
BF. 74	BD.813	PIPING - wings to body (black plastic) Car set	£35.15
BF. 76		FLAT WOVEN TAPE around radiator grille	£16.20
BF. 81		KEYS - FNR series - all numbers from 1 - 50 - state number required	£9.90
BF. 87	BD. 1834	LOCK BARREL (with pin & bolt) for exterior door handle (+keys) Coupe	£20.40
BF.106		PETROL PUMP FITTING KIT (studs, grommets, washers & nuts)	£8.90
BF.116	C.2291	GEAR LEVER KNOB	£20.40
BF.117	BD.2191	BRACKET SECURING SUNROOF (Plated)	£25.10 pair

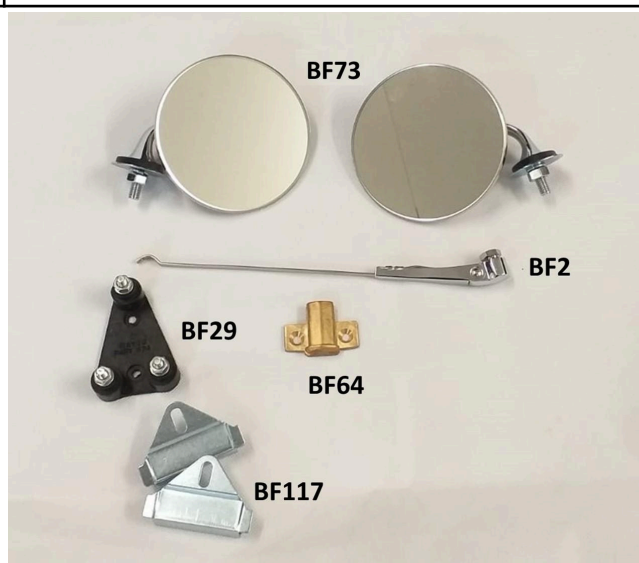

RUBBER SEALS AND GASKETS

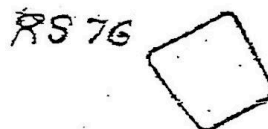
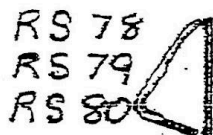
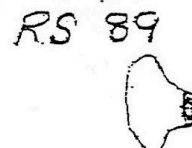
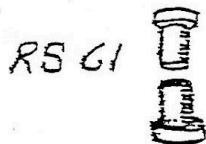
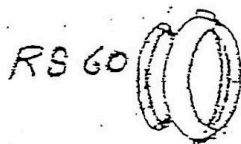
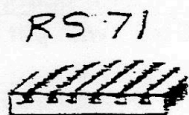
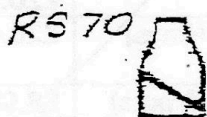
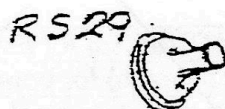
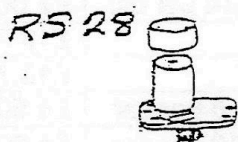
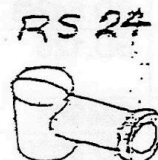
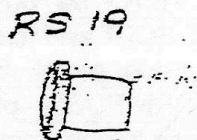
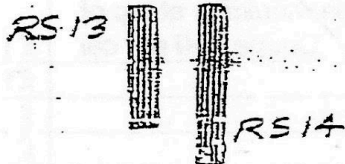

RUBBER SEALS & GASKETS



RS. 7	C2839	SU PUMP RUBBER SLEEVE	£8.45
RS. 8	BD.1207	WINDSCREEN SEAL	£19.25
RS. 13	792	RUBBER PEDAL PAD - brake and clutch	£9.50 pair
RS. 14	C.3473	RUBBER PEDAL PAD - accelerator	£7.30
RS. 19	1048/A	FRONT JACK HOLE BUNG	£6.95
RS. 22	552688	HEADLAMP GASKET - lamp to car body	£5.30
RS. 24	C.4650	BOOT for starter solenoid	£3.80
RS. 28	C.2659	PAD for dipper switch	£12.50
RS. 29	C.3673	DRAUGHT EXCLUDER - brake and clutch pedal	£7.80 each
RS. 50	C.1788	CONNECTING RING between intake pipe and air cleaner 2.5 & 3.5L	£17.85
RS. 60		DUST SEAL for PF770 headlamp - between outer rim and light unit	£6.30
RS. 61	C.1915	BUSH/BEARING for gear lever	£14.10 pair
RS. 62		REAR WHEEL SPAT SEAL	£9.80 pair
RS. 64	BD2517	RUBBER GROMMET in body sill for front and rear door check strap. Fitted to chassis numbers 520001 & subsequent, 620056 & subsequent (RHD) and also 527001 & subsequent and 627049 & subsequent (LHD), 4 per car	£57.75 each
RS. 69	814	STEERING COLUMN GROMMET	£19.70

RS. 70	734181	RUBBER GROMMET for windscreen wiper spindle	£8.50 each
RS. 71	BD.2249	RUBBER MAT in step bead frame (front wing running board chromes)	£54.45 car set
RS. 72	BD.1997	FILLER HOSE - tank to filler cap	£25.30
RS. 73		SEALING RUBBER around door apertures - saloon Front door seal (280cm) - £19.52 per door Rear door seal (250cm) - £17.50 per door	£74.00 car set
RS. 74	BD.2045/6	SEALING RUBBER around door apertures - coupe	£23.70
RS. 75		SEALING RUBBER around boot lid - all coupes & late saloons: chassis numbers 520413 onwards, 527074 onwards, 621520 onwards & 627429 onwards.	£16.50
RS. 76	BD.2065	PETROL FLAP SEAL	£13.95
RS. 78		FRONT ¼ -LIGHT SEAL - saloon This ¼ -light seals are the correct section of rubber but require some hand fitting - cut at pivot point, turn around, repeat at second pivot point, then glue ends together at joins. The vertical rubber seal (BD.46/4) at rear of ¼ -light is included)	£28 pair
RS. 79	BD.3969/3970	FRONT ¼ -LIGHT SEAL - coupe This ¼ -light seals are the correct section of rubber but require some hand fitting - cut at pivot point, turn around, repeat at second pivot point, then glue ends together at joins. The vertical rubber seal (BD.46/4) at rear of ¼ -light is included)	£28 pair
RS. 80		REAR ¼ -LIGHT SEAL – saloon This ¼ -light seals are the correct section of rubber but require some hand fitting - cut at pivot point, turn around, repeat at second pivot point, then glue ends together at joins. The vertical rubber seal (BD.46/4) at rear of ¼ -light is included)	£28 pair
RS. 82	C.2979	GROMMET for bulb-holder of rear lamp	£11.35
RS. 83	571979	GASKET for rear lamp - chrome rim to lamp	£15.45
RS. 86	3204	GROMMET in spark plug cable bracket	£14.45
RS. 88	593	BONNET REST RUBBER on scuttle	£16.75
RS. 89		LANDAU BAR GROMMETS	£31.20 each
RS.103	BD2159	SEAL for spare wheel door channel on bottom of door (sealing around spare wheel door aperture - BD.2167/1 - not available)	£6.10
RS.104	BD2059	FRONT SUNROOF SEAL	£10.65
RS.105	BD2058/1	REAR SUNROOF SEAL	£5.95
RS.114	BD213/1	RUBBER EXTRUSION in the chrome beading/strips on the boot floor and on the tool tray Car set	£19.70

ELECTRICAL PARTS

ELECTRICAL PARTS

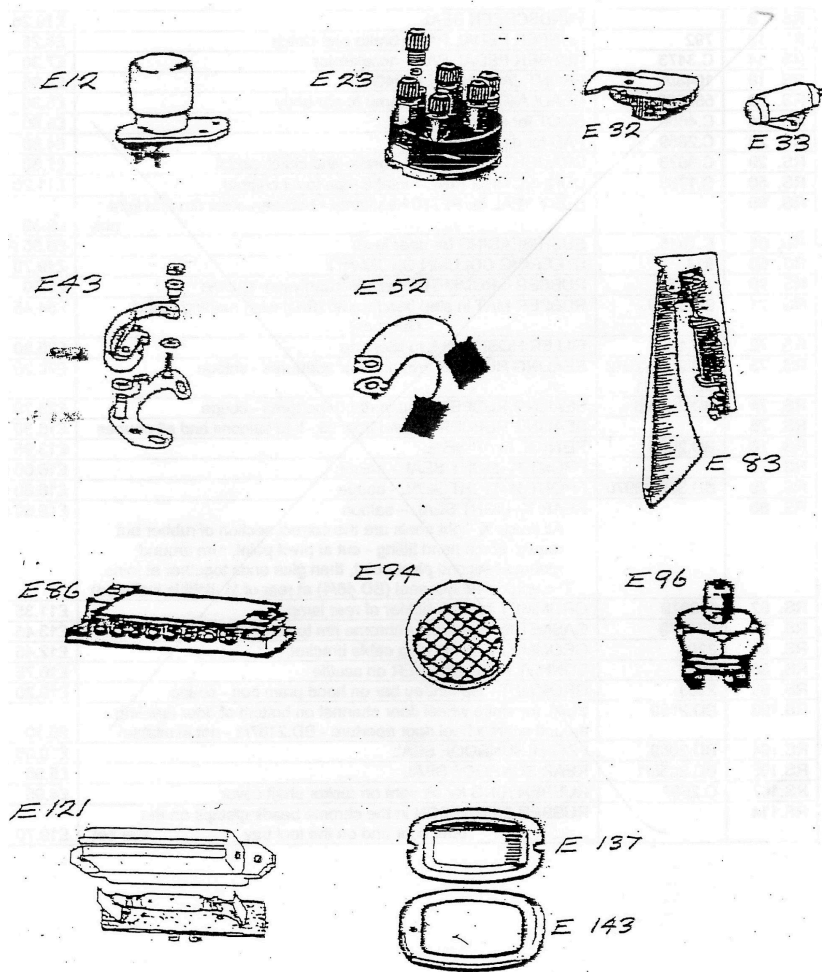

E. 12	C.2639	DIP SWITCH - foot operated	£31.35
E. 15	C.4613	SWITCH for map light/heater motor	£32.00
E. 17		INTERIOR LIGHT LENSES	£78 pair
E. 23	2927	DISTRIBUTOR CAP - (Lucas 407043) - the cables enter this cap vertically, not horizontally as original. Will fit distributors normally fitted with cap 415708	£35.85
E. 27	C2558	REAR NUMBER PLATE ILLUMINATION & REVERSE LIGHT - complete unit (including bulb) 2 per car	£142.50 each
E. 28	572694	RIM & GLASS ASSEMBLY for rear number plate illumination and reverse light.	£50.75
E. 29	C2692	STARTER SOLENOID	£29.50
E. 31	2926	ROTOR ARM	£7.35
E. 33	2928	CONDENSER	£11.95
E. 43	2929	CONTACT SET	£10.20
E. 52	2804	BRUSHES for starter motor Set of 2	£9.60
E. 53	C2530	VOLTAGE CONTROL BOX RF95/2 Original rebuilt item £50 discount available if old control box (in repairable condition) is sent in exchange.	£275
E. 56	571997	REAR BRAKE LIGHT LENSES with 3 heavy ribs. New reproduction, made from acrylic.	£76 pair

E. 71	"C4099"	FRONT SIDELIGHT The original bulb holder for this sidelight is within the sidelight pod on the front wing. This reproduction sidelight comes with a detachable bulb holder: the bulb holder is retained if the original is unusable, but can be removed if the original is still in good condition. This reproduction bulb holder is designed to take a twin filament bulb. Please note the lens is plastic, not glass.	£55.75 each
E. 83	BD.1804	TRAFFICATOR - professionally reconditioned Sold as a pair (for single units please ask)	£480 exchange £580 outright
E. 86	C.2532	CONNECTOR BLOCK (electrical wiring connector)	£26.00
E. 94	57124	RED REFLECTOR with chrome surround - 2" diameter, with bolt fixing. Not a Jaguar part but a "period addition" to comply with law	£25.45 pair
E. 96	C.3901	BRAKE LIGHT SWITCH - hydraulic - for LHD cars	£15.30
E. 99	C.2613	BRAKE LIGHT SWITCH - mechanical - for RHD cars	£32.70
E.121	319003	LENS for map light	£42.30
E.124/5		H.T. CABLE/WIRE for spark plugs and coil - one length of cable	£27.60
E.127	"C.2528"	IGNITION COIL - 12v coil with screw-down fittings (not the original Lucas sports coil)	£25.80
E.136	513	GROMMET in scuttle/bulkhead for water temperature/oil pressure pipes	£6.60
E.137	532949	LENS/WINDOW for boot/tool tray light	£15.25
E.143	532948	CHROME SURROUND for boot light above	£11.40
E.169		SPARK PLUGS – Please state full engine number if 2.5/3.5L	£5.95 each

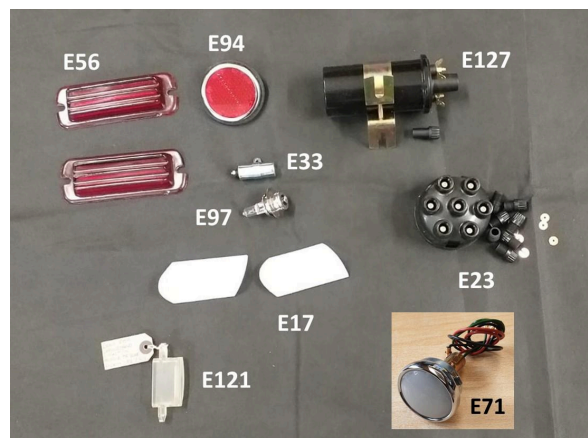

BRAKES

Early Braking System - Chassis Numbers as Follows

520001 - 520657 (2.5L saloon) 527001 - 527120
620001 - 622581 {3.5L saloon} 627001 - 627776
640001 - 640005 {3.5L coupe} 647001 - 647009
(Early system not fitted to 2.5L coupes)

Late Braking System - Chassis Numbers as Follows

520658 onwards {2.5L saloon} 527121 onwards
622582 onwards {3.5L saloon} 627777 onwards
640006 onwards {3.5L coupe} 647010 onwards
All 2.5L coupes

BR. 16		LININGS AND RIVETS - front for <u>early</u> system as above; front and rear for <u>late</u> system as above	£68.75 axle set
BR. 17		REAR LININGS AND RIVETS for <u>early</u> system as above Axle set	£42.50
BR. 21		MASTER CYLINDER - RHD	Exchange: £420 Outright: £520
BR. 22		MASTER CYLINDER- LHD	Exchange: £420 Outright: £520
BR. 39	H.2736	WHEEL CYLINDER - front left - early system - when available	£126.00
BR. 40	H.2737	WHEEL CYLINDER - front right - early system - when available	£126.00
BR. 45	H.3152	WHEEL CYLINDER (handbrake draw link not included) - rear left – late system - Refurbishment of customer's own cylinder only . Please see alternative below	£140
BR. 46	H.3153	WHEEL CYLINDER (handbrake draw link not included - rear right-late system - Refurbishment of customer's own cylinder only . Please see alternative below	£140
BR. 45/46A	"H.3152" & "H.3153"	<u>ALTERNATIVE</u> WHEEL CYLINDERS - rear left & right, late system - 1 inch cylinders with a 2 stud fixing (not as original but a suitable alternative). These could be fitted if the originals are not available, or for instance, if the old cylinders are not in a suitable state to be rebuilt.	£215 pair
BR. 54		REPAIR KIT - master cylinder Rubber seals only Complete kit	£15.10 £25.80
BR. 67		REPAIR KIT - front cylinders for <u>late</u> system as above	£12.45 Axle set
BR. 68		REPAIR KIT - rear cylinders for <u>late</u> system as above - <u>please note</u> : with regard to late rear cylinders, there are two alternatives which both look identical on the outside. The most common version, which uses repair kit BR.68, has a piston that pushes the seal. The other version has a piston which is grooved and requires a seal in the form of a ring that fits into the groove. This version requires repair kit BR.141.	£15.15 Axle set
BR. 69		REPAIR KIT - front cylinders for <u>early</u> system as above	£14.95 Axle set
BR. 70		REPAIR KIT - rear cylinders for <u>early</u> system as above. This consists of the 4 rubber seals but does not include the rubber spreaders (reference H.1483)	£20.60 Axle set
BR. 98		FLEXIBLE BRAKE HOSE - front left or right	£21.65
BR. 99	H0221	FLEXIBLE BRAKE HOSE - rear	£19.50
BR.126	C.4022	HAND BRAKE CABLE ASSEMBLY at rear - <u>late</u> system as above	£56.00

BR.127	C.3378	FRONT CABLE from hand brake to intermediate lever - RHD - Chassis Nos 520001 to 521365 and 540001 to 540010 (2.5L), 620001 to 624313 and 640001 to 640064 (3.5L)	£49.75
BR.128	C.4799	FRONT CABLE from hand brake to intermediate lever - LHD and RHD - Chassis Nos. 521366 onwards and 540011 onwards (2.5L), 624314 onwards and 640065 onwards (3.5L)	£49.90
BR.135	GB.40631	RETURN SPRING for front brake shoes - <u>late</u> system as above	£13.30
BR.141		REPAIR KIT - rear wheel cylinders (alternative to BR.68 - late braking system)	£18.65 Axle set
BR.153	H.1278/H	HOSE between supply tank and copper pipe	£7.05
BR.161		BRAKE LIGHT SWITCH – RHD only	£32.85

EXCHANGE CYLINDERS - please note that to qualify for an exchange, returned cylinders must be in a restorable condition and of the same specification as the replacement cylinder which we send. Cylinders with broken or missing studs do not qualify as an exchange as the studs cannot be replaced.

LATE System FRONT Cylinders

These cylinders for the Mk 5 front late braking system are virtually impossible to obtain. There is a possibility that old cylinders could be professionally rebuilt but we have found that due to the brittle nature of this particular cylinder it is only a low percentage that are found to be suitable for rebuilding. Certainly if there is any damage to the studs these cannot be replaced and the cylinder is scrap.

There is an alternative cylinder that we can obtain but it does require a modification - the area on the cylinder that locates the end of the brake shoe needs to be machined to match the original. Also the hole centers are a slightly different dimension and require the back plate holes to be filed out by a small amount.

£272 for set of 4



SUSPENSION AND STEERING

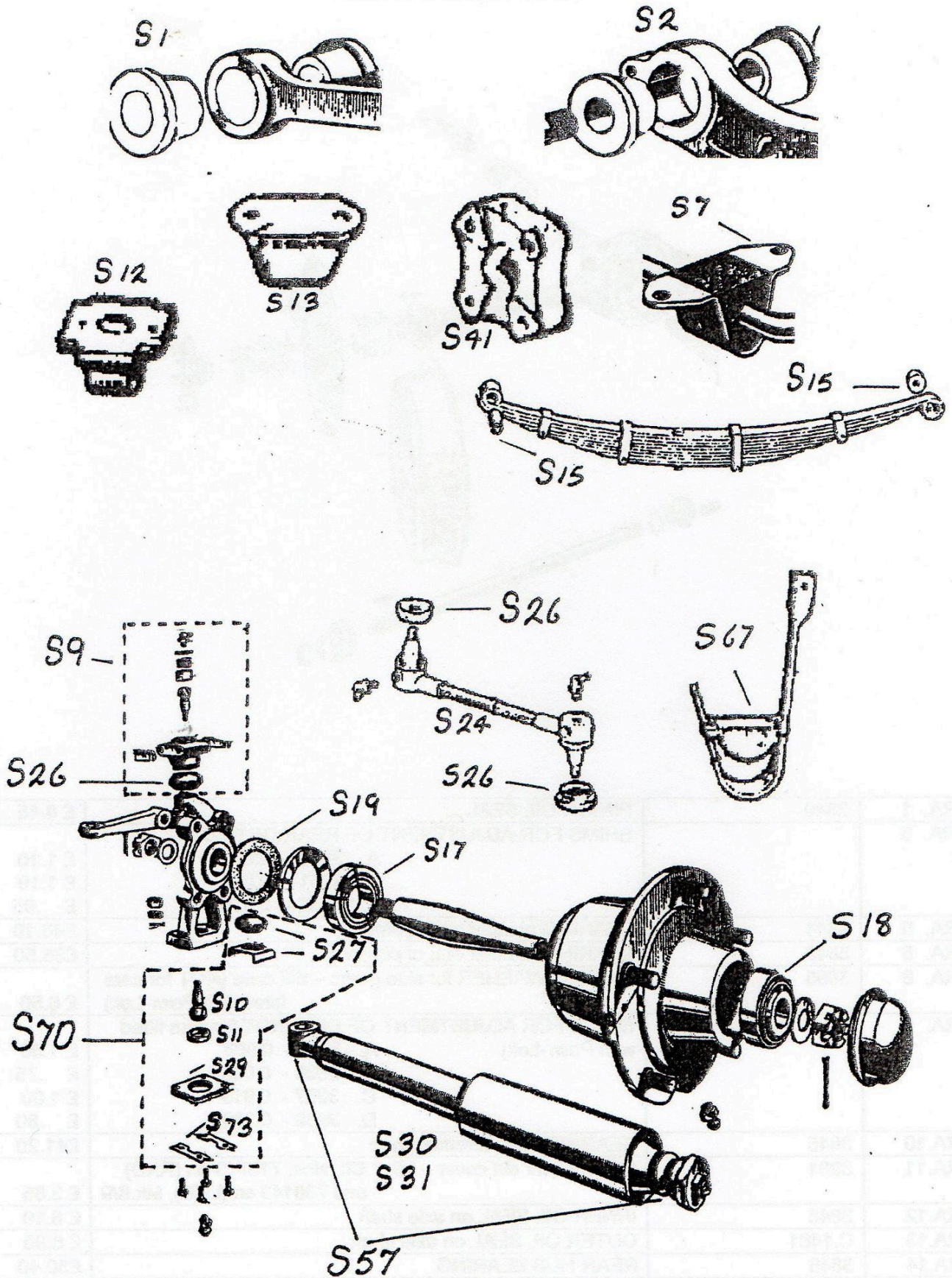

SUSPENSION & STEERING



S. 1	C.3003	TOP WISHBONE BUSH 8 per car	£5.40 each
S. 2	C.3021	BOTTOM WISHBONE BUSH 8 per car	£6.15 each
S. 7	C.3054	BRACKET over bearing - anti-roll bar link 2 per car	£18.20
S. 9		UPPER BALL JOINT ASSEMBLY	£37.65
S. 10	C.3022	LOWER SWIVEL PIN and nut (bottom ball joint)	£12.30
S. 11	C.3025	SEAT/SOCKET supporting lower ball pin - see also S.70 - <u>Note:</u> the seat/socket supplied is a version that has an integral spigot/seating ring. If your car is presently fitted with the original bronze socket and a separate spigot (Jaguar No. C.3024), <u>do not attempt to refit the spigot</u> - discard it	£10.15
S. 11/A		SEAT/SOCKET supporting lower ball pin - original bronze type – comes complete with separate spigot.	£20.30
S. 12	C.3036	FRONT BUMP STOP 2 per car	£12.85 each
S. 13	C.3208	REAR BUMP STOP 2 per car	£12.45 each
S. 15	C.1219	BUSH in front eye of rear road spring 2 per car	£5.30
S. 16	C.3334	BUSH for shackle and rear eye of rear road spring 8 per car	£8.75 each
S. 17	C.3011	FRONT WHEEL INNER BEARING 2 per car	£27.90 each
S. 18	C.3012	FRONT WHEEL OUTER BEARING 2 per car	£26.85 each
S. 19	C.615	FELT GREASE RETAINER - front hub	£2.80

S. 20	C.3062 C.3063	TRACK ROD ENDS - Chassis Nos. 520001 to 521476, 527001 to 527190, 540001 - 540016 and 547001 - 547012 (2.5L), 620001 to 625201, 627001 to 628894, 640001 - 640147 and 647001 - 647534 (3.5L)	£69.80 pair
S. 23		TRACK ROD ASSEMBLY - fitted to 521477 on, 527191 on, 625202 on, 628895 on, 540017 on, 547013 on, 640148 on and 647535 on	£134.50 pair
S. 26	C.3020	RUBBER GAITER for track rod end/tie rod end and top ball joint	£3.45
S. 27	C.3029	GAITER AND RETAINING PLATE for lower ball pin joint (made to ensure they <u>do</u> fit together) - see also S.70	£10.90
S. 29	C.3026/1	SHIM for bottom ball joint - see also S.70	£2.10
S. 50	27-9-4	OIL SEAL in steering box at bottom of trunnion for rocker shaft	£5.35
S. 52		PIN AND BUSH for centre track rod assemblies (see Item No. 65 on 'Plate CZ in Mk.5 parts book) This is a replacement pin and bush for 'End Assemblies' for track rods C.4135 and C.4136. It can also be used for the earlier track rod ends C.3493 and C.3494 - these had a threaded pin. The thread in the track rod ends has to be machined out to enable this later version of the pin and bush to be fitted.	£35.00
S. 54	C614	COVER PLATE over grease retainer.	£12.75
S. 55	C.3035	FRONT SHOCK ABSORBER and bushes (sold in pairs only)	£181.50 pair
S. 58		BUSH KIT for front shock absorber (1 kit per shock absorber)	£18.45
S. 67	632	BUFFER at bottom of check strap - rear axle	£17.60
S. 70		LOWER BALL JOINT KIT - comprising lower swivel pin and nut, seat, gaiter, retaining plate, 2 lock plates, 2 shims	£37.50
S. 73	C.3028	LOCK PLATE for lower ball joint (2 per side) - see also S.70	£2.90 pair
S. 74		ANTI-ROLL BAR BUSH KIT (10 items - link bushes and bush/bearing on chassis)	£25.50
S. 81	C.3203	STEERING IDLER SEAL	£3.70
S. 93		OIL for lever arm shock absorber	£28.50 per litre
S. 98		BUSH for link arm - rear lever-arm shock absorber - considerable force is required to press these into the links. 4 per car	£8.70 each

ENGINE

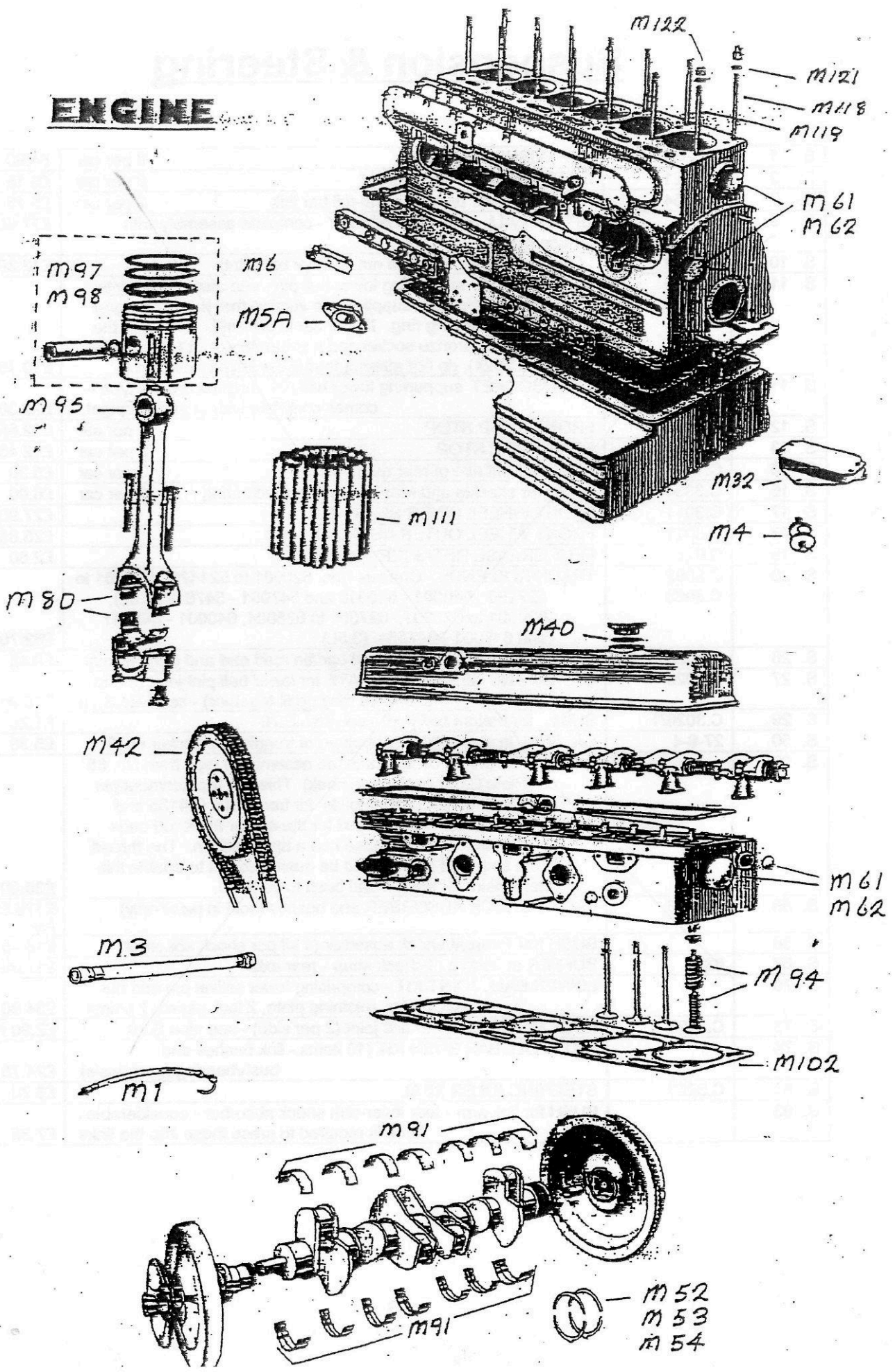

ENGINE

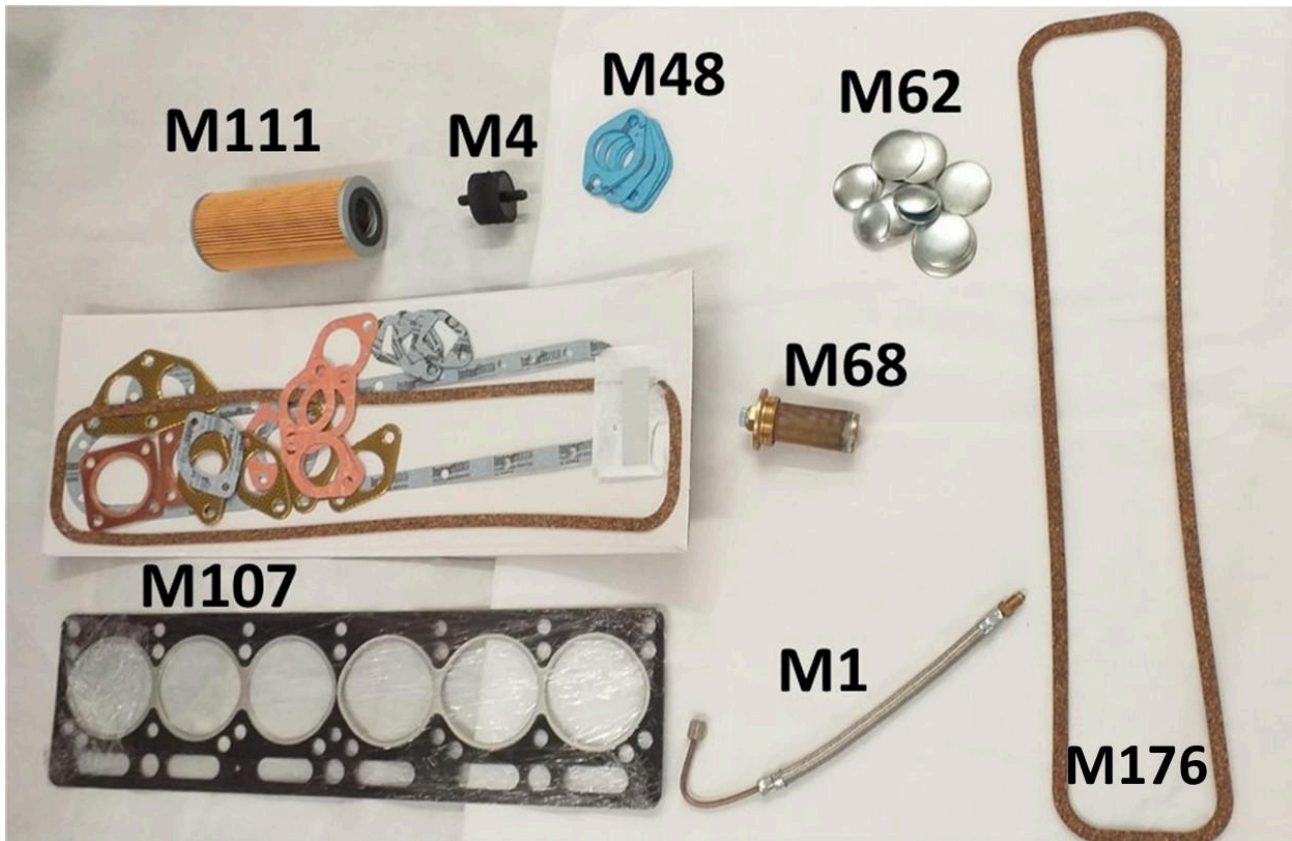

M. 1	1423A	FLEXIBLE OIL PIPE from oil cleaner to pressure gauge	£24.95
M. 3	C.3629	FLEXIBLE FUEL LINE connecting feed pipe to carburettors	£28.20
M. 4	C.4304	REAR ENGINE MOUNT - Chassis Nos. 521354 onwards, 527165 onwards, 540006 onwards, 547004 onwards (2.5L), 623892 onwards, 628121 onwards, 640034 onwards, 647131 onwards (3.5L), and also fitted to 24 individual, non-consecutive 3.5L chassis numbers prior to those listed above - check with your parts book. 2 per car	£11.75 each
M. 5A	C.4303	FRONT ENGINE MOUNT - chassis numbers as at M.4 above 2 per car	£10.55 each
M. 6	C.428	FRONT ENGINE MOUNT - Chassis Nos. 520001 - 521353, 527001 - 527164, 540001 - 540005 and 547001 - 547003 (2.5L), 620001 - 623795, 627001 - 628080, 640001 - 640029 and 647001 - 647121 (3.5L), and also fitted to approx. 100 other 3.5L individual, non-consecutive chassis numbers, all later than those listed above - check with your parts book	£18.35
M. 29	310	RETURN SPRING for carburettor	£3.45
M. 32	C.478	GEARBOX MOUNT - Chassis numbers as at M.6 above	£29.80
M. 40	C.419	FIBRE GASKET on oil filler cap	£1.55
M. 42	C.1614	DUAL TIMING CHAIN	£25.60
M. 48	C346	INLET MANIFOLD GASKET SET between carburettor & head and air cleaner. 3.5L only	£27.50 set
M. 52	C.559/C.462	THRUST WASHERS - please state size: standard, +5, +10	£35 set
M. 61		CORE PLUG SET - 2.5L	£20.95
M. 62		CORE PLUG SET - 3.5L	£17.05
M. 66	C.540	SPRING for timing chain tensioner Please note: this is an alternative type spring, not exactly as original	£19.25
M. 68	C.990	PETROL TANK FILTER/DRAIN PLUG	£59.25

M. 71	C.937	CORK GASKET between sender unit and fuel tank	£1.05
M. 72	C1617	GASKET/WASHER for petrol tank filter	£1.75
M. 80	SPECIAL ORDER	BIG END BEARINGS - 3.5L - for engines with <u>steel con rods</u> – standard, +10, +20, +30, +40, +60 thousandths of an inch – state oversize required	£79.50 car set
M. 80A	SPECIAL ORDER	BIG END BEARINGS - for engines with <u>alloy con rods</u>	Please ask
M. 91	SPECIAL ORDER	MAIN BEARINGS for 2.5 & 3.5L Standard, +10, +20, +30, +60 State oversize required	£305 car set
M. 93	2x C411 1x C638	GASKET SET FOR WATER UPTAKE MANIFOLD - 2.5L	£15.50 set
M. 95	C2439	SMALL END BUSHES - 3.5L - for engines with steel con rods - set of 6	£46.50 set
M. 96	3x C411	GASKET SET FOR WATER UPTAKE MANIFOLD - 3.5L	£14.75 set
M. 97	C.2562	PISTONS, rings and gudgeon pins - 3.5L - standard, +20, +30, +40, +60 thousandths of an inch oversize - state oversize required (+10 not available) - obtained to order only	£625.80 car set
M. 98	C.2565	PISTONS, rings and gudgeon pins - 2.5L - standard, (+10 not available) +20, +30, +40, +60 thousandths of an inch oversize - state oversize required - obtained to order only	£625.80 car set
M. 99	C328, C4201	VALVE GUIDES - inlet and exhaust	£28.50 each
M.100	FW105E	COPPER WASHER - 5/16"	£0.50 each
M.101	C.531	FAN BELT	£30.40
M.102	C.337	CYLINDER HEAD GASKET - 3.5L COMPOSITE	£215
M.103		CYLINDER HEAD GASKET - 2.5L COMPOSITE	£215
M.106		CYLINDER HEAD GASKET SET - 2.5L with composite head gasket	£330.00
M.107		CYLINDER HEAD GASKET SET - 3.5L with composite head gasket	£330.00
M.109		CONVERSION GASKET SET - 2.5L & 3.5L	£95
M.111		OIL FILTER	£17.25
M.118	C.339	STUD securing cylinder head - 3.5L - 6 per car	£15.20 each
M.119	C.340	STUD securing cylinder head - 3.5L - 8 per car	£15.20 each
M.121	C.789	WASHER on cylinder head studs - 14 per car, supplied as a set of 7	£9.20 per set of 7
M.122	C.2138	CAP NUT for cylinder head studs (cap not supplied) - 7 per car	£3.10 each
M.128	FN 107/L	BRASS END TERMINAL for spark plug lead - 6 per car	£1.95 each
M.144	C380	TIMING COVER GASKET 2.5/3.5L	£18.50
M.145		LOCK NUT securing valve clearance adjustment screw - 12 per car	£2.15 each
M.169	C.385	SUMP/OIL PAN GASKET	£27.10
M.174		EXHAUST VALVES - 3.5L, sold as set of 6	£235 set
M.175		INLET VALVES - 3.5L, sold as a set of 6	£235 set
M.176	C.457	ROCKER BOX GASKET - 3.5L extra thick (4mm)	£23.50
M.177	C.810	ROCKER BOX GASKET - 2.5L extra thick (4mm)	£23.50
M.179A		SMALL END BUSHES - 2.5L only (set of 6) 1938-1951	£97.50
M180		EXHAUST VALVES 2.5L, sold as a set of 6	£228 set
M181		INLET VALVES 2.5L, sold as a set of 6	£228 set
M182		OIL PUMP - reconditioned original when available. £50 discount for serviceable exchange.	£175

EXHAUST

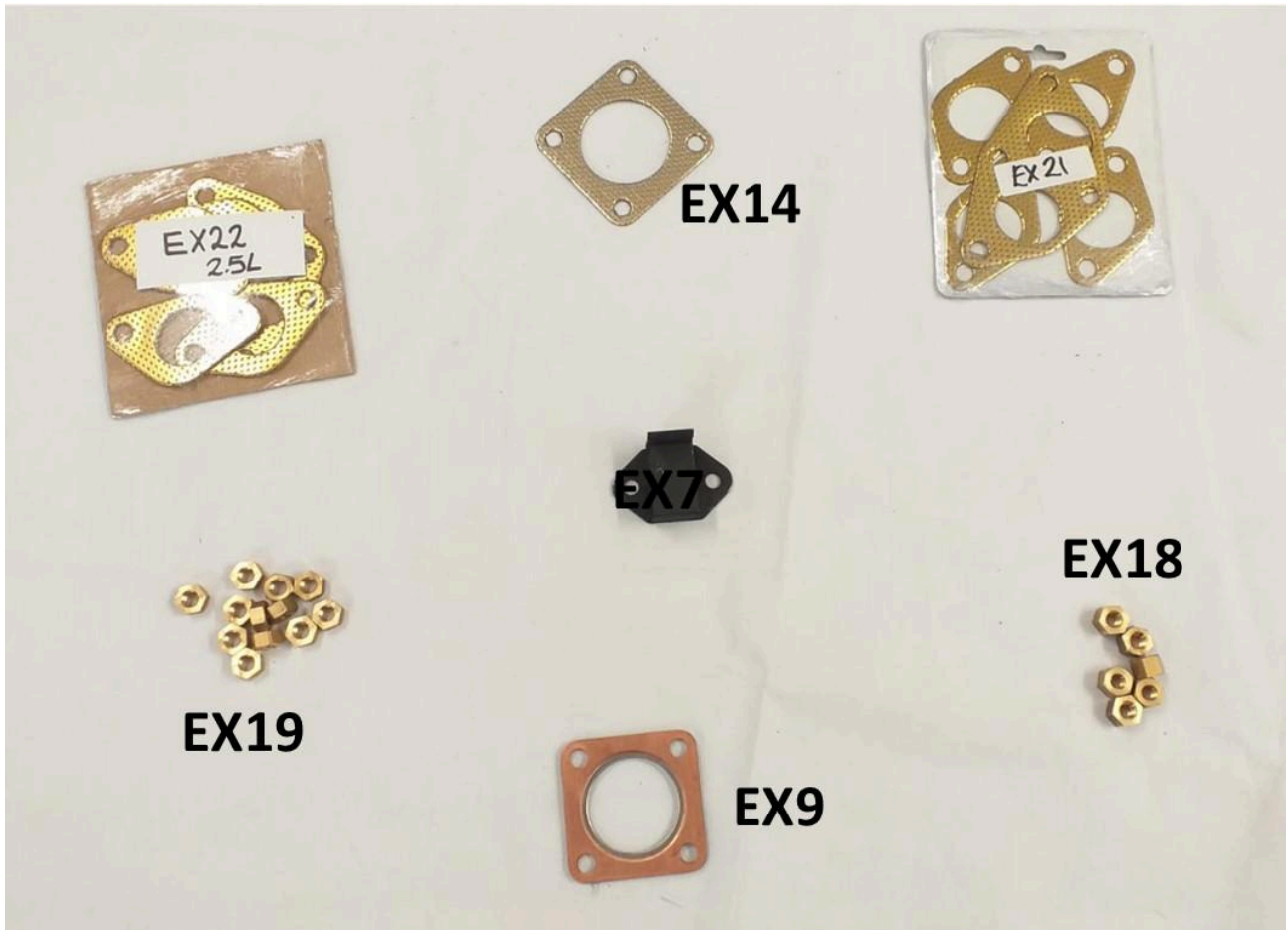

EX. 7	1363	RUBBER MOUNT - right-angled - for silencers	2 per car	£4.30
EX. 9	C.495	GASKET between exhaust manifold and downpipe		£12.55pair
EX. 14	C.3584	GASKET between downpipe and intermediate pipe		£5.85
EX. 16		EXHAUST MANIFOLD STUDS & NUTS for connecting the manifold to the downpipe. 3/8" UNF x 7/16" These are stepped studs to be used after a new thread has been tapped, following drilling out the remains of the old ones. Sold in packs of 4 studs & 4 nuts. 2.5/3.5L - 2 packs per car		£21.50 pack of 4
EX. 18	FN.106K	BRASS NUT securing exhaust pipes to exhaust manifold	8 per car	£12.45 set
EX. 19	FN.106	BRASS NUT securing exhaust manifold to cylinder head.	12 per car	£16.15 set
EX. 21		Exhaust manifold gasket set – 3.5L		£35.50
EX. 22		Exhaust manifold gasket set - 2.5L		£35.50

CLUTCH

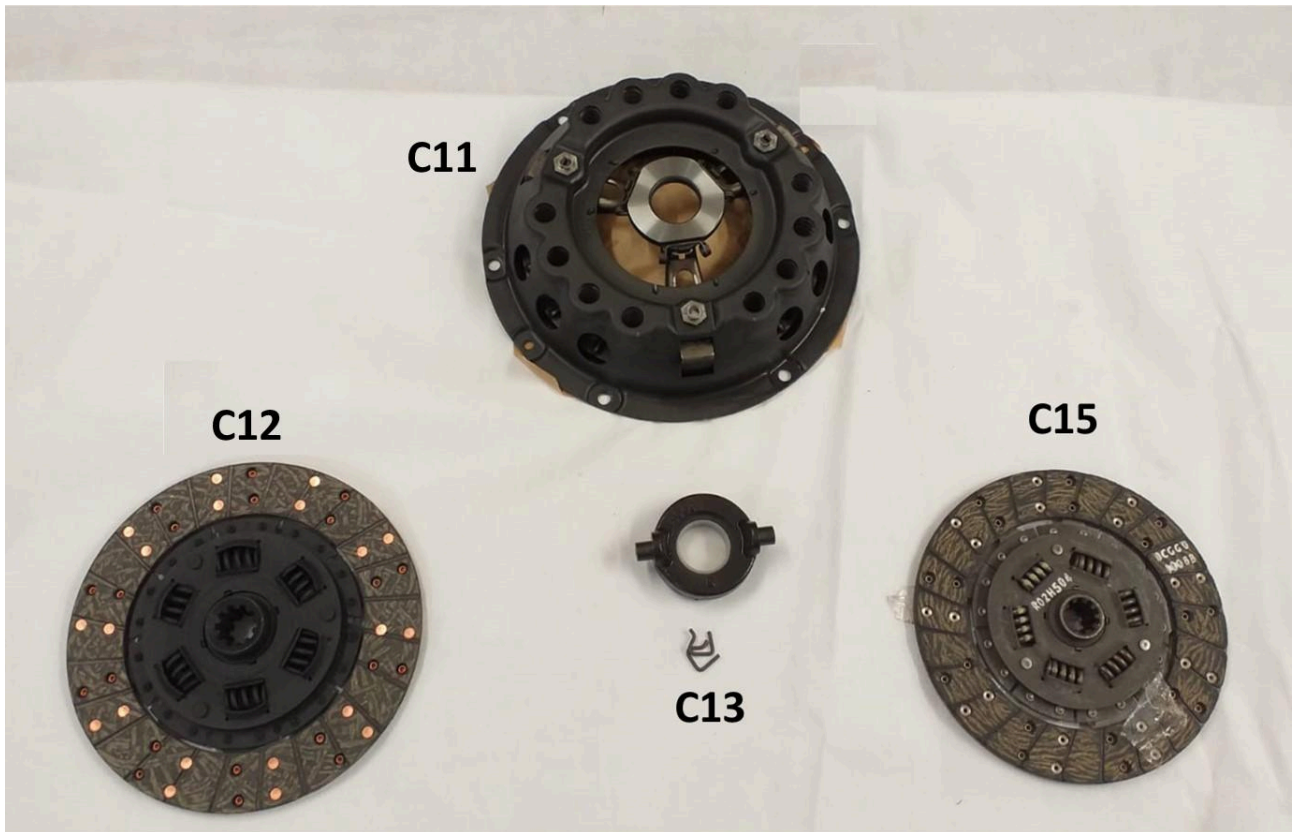

(All surcharges are refundable upon receipt of the old unit)

C. 11		CLUTCH PRESSURE PLATE - 10" - 3.5L	EXCHANGE SURCHARGE	£125 £80
C. 12		FRICION PLATE - 10"	EXCHANGE SURCHARGE	£62 £50
C. 13		RELEASE BEARING		25.75
C. 14		CLUTCH PRESSURE PLATE - 9" - 2.5L	EXCHANGE SURCHARGE	£125 £80
C. 15		FRICION PLATE - 9"	EXCHANGE SURCHARGE	£62 £50

GEARBOX

G. 2	C.1850	NEEDLE ROLLER in 2nd and 3rd speed gears	Set of 82	£44.50 set
G. 3	C.918	NEEDLE ROLLER	Set of 58	£37.40 set
G. 6	C.912	OIL SEAL at front end of gearbox		£4.95
G. 7	C.859	OIL SEAL at rear end of gearbox		£6.10
G. 27	C.924	BEARING in gearbox extension (SH10 on, JH10 on)		£50.25
G. 29	C.883	ROLLER BEARING for main shaft		£100.85
G. 30		GASKET SET - SH and JH gearboxes		£12.90
G. 31	C.1845	BEARING for main shaft, fitted to SH10-SH6148 gearboxes		£42.85
G. 32	C.1838	BEARING - constant pinion shaft		£34.80

TRANSMISSION

TR. 1	94/GB.1598	GREASE NIPPLE for universal joint - propshaft		£2.00
TR. 2	K.5/L/4	UNIVERSAL JOINT/JOURNAL ASSEMBLY with grease nipple. Genuine Hardy Spicer 3 per car		£25.40 each
TR. 3	94/GB.2147	BEARING for propshaft center mount		£42.80
TR. 4	C.3930	INSULATOR in mounting plate flanges for propshaft 2 per car		£17.50, each
TR. 6	K.2/2/239	FLANGE YOKE on front propshaft assembly and at each end of rear propshaft assembly		£31.90
TR. 7	K.2/3/68	SLEEVE YOKE ASSEMBLY on sliding end of rear propshaft assy		£38.35

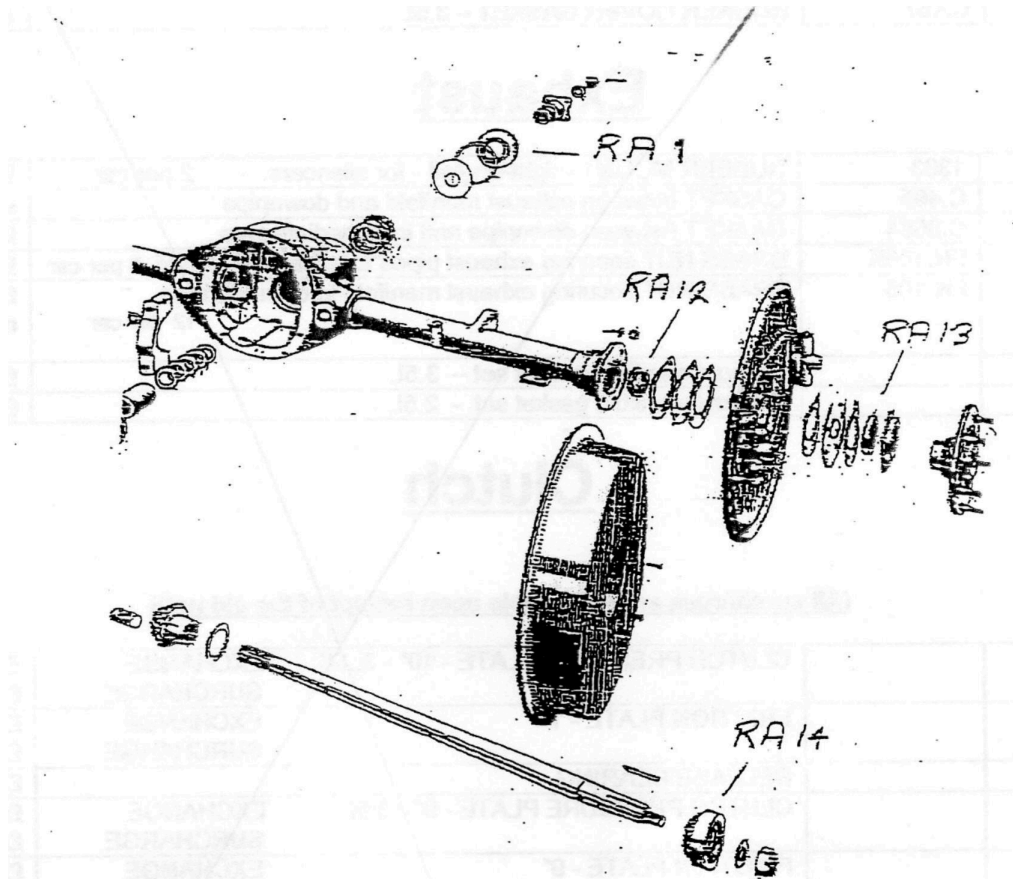

REAR AXLE

SALISBURY AXLE

RA. 1	2HA-019	PINION OIL SEAL	£ 8.85
RA. 2	2HA-020	GASKET for pinion oil seal	£1.78
RA. 5	2HA-023	BEARING at inner end of pinion	£48.20
RA. 6	2HA-022	BEARING at outer end of pinion	£38.15
RA. 8	2HA-038	THRUST WASHER for side gears	£16.50 pair
RA. 10	2HA-024	BEARING on differential case (2 per car)	£43.05 each
RA. 12	2HA-027 3848	INNER OIL SEAL on axle shaft (2 per car)	£6.40 each
RA. 13	2HA-032	OUTER OIL SEAL on axle shaft (2 per car)	£7.25 each
RA. 14	3846	REAR HUB BEARING (2 per car)	£31.70 each

ENV AXLE

RA. 17	801	OIL SEAL - rear hub	£7.70
RA. 18	C.3041	WHEEL NUTS - front and rear	£3.10 each
RA. 19	A-254-12	OIL SEAL - axle shaft	£10.60
RA. 20	H-105-22	PINION OIL SEAL	£36.80
RA. 21	A-254-63	HUB BEARING	£39.50 each
RA. 22	A-254-63	BEARING each side of differential gear	£39.50 each
RA. 23	H-108-41	FRONT PINION BEARING	£29.36
RA. 24	H-108-40	REAR PINION BEARING	£42.50

CABLES

CB. 10	C.1434	SPEEDOMETER CABLE	£33.85
CB. 15	C.2874	REV COUNTER CABLE - 2.5L	£35.40
CB. 16	C.2856	REV COUNTER CABLE - 3.5L	£35.40

REPLACEMENT PANELS

P. 45	52043A	FRONT SIDELIGHT HOUSING - to be welded onto front wing – metal pod/housing only	£147.86
P. 46		FRONT VALANCE/PLINTH PLATE ASSEMBLY above front bumper	£125.40
P. 47		REAR VALANCE/PLINTH PLATE ASSEMBLY above rear bumper	£125.40

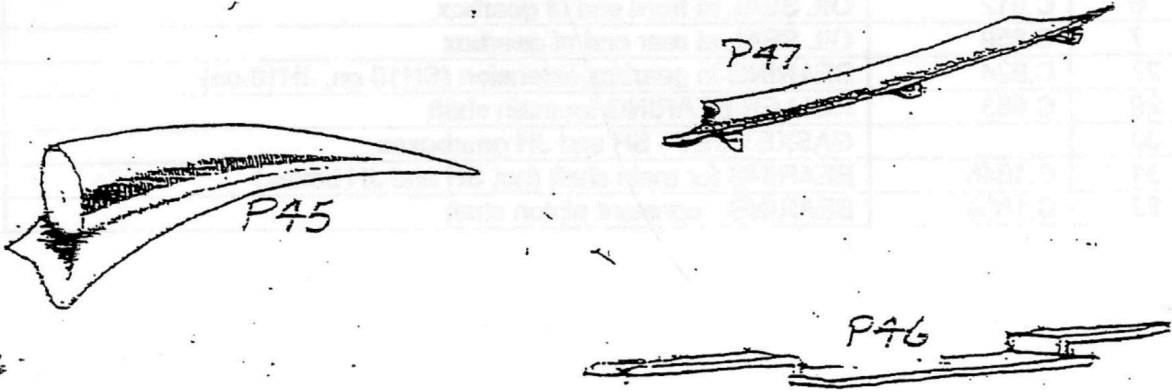

COOLING SYSTEM

CS5	C2819	BY-PASS HOSE for 3.5L (previously CS41)	£15.20
CS6	C705	WATER PUMP BEARING - front	£15.25
CS7	C706	WATER PUMP BEARING - rear	£15.95
CS18	C714	RUBBER SEALING RING for filler cap (previously CS38)	£4.40
CS19	C384	CARBON GLAND BUSH for water pump - 1.5L, 2.5L & 3.5L (previously CS46)	£32.65
CS20	C1506	BOLT AND TWO COPPER WASHERS securing banjo on water pump- all 2.5 only	£9.87
CS31		HEATER HOSE KIT	£43.90
CS32	C3498	TOP RADIATOR HOSE	£19.75
CS33	C3499	BOTTOM HOSE	£21.95
CS34	C2821	BY-PASS HOSE for Mk 5 2.5L only	£15.80
CS39	C2810	BACK PLATE FOR WATER PUMP (new reproduction)	£155

TOOLS

T. 1	pt of C997	HANDLE FOR TYRE PUMP as fitted to Mk 4/5/XK120	£14.50
T. 2	C.993	EXTRACTOR FOR TYRE VALVE	£9.00
T. 3	C3798	TEE KEY	£14.50
T. 4	C.994	ADJUSTABLE SPANNER - original second-hand	£16.05
T. 5	C2954	JACK RATCHET HANDLE (used original)	£28.00
T. 7	C.991	OIL GUN/GREASE GUN - original second-hand	£53.80
T. 11		WOODEN HANDLED SCREWDRIVER (used)	£13.75
T. 12	C31	BOX SPANNER - new reproduction 3/16 x 1/4	£35
T. 13	C32	BOX SPANNER - new reproduction 5/16 x 3/8	£35
T. 14	C33	BOX SPANNER - new reproduction 7/16 x 1/2	£35
T. 17	C31, C32, C33	BOX SPANNERS - set of 3 which 'nest' (fit inside each other).	£105 set
T. 18	C179	SINGLE ENDED BOX SPANNER for spark plugs	£35
T. 19	C2585	BOX SPANNER for torsion bar adjustment	£38.50
T. 24	C.13620	DUNLOP BLEED TUBE TIN - exact replica with lid screen-printed in same way as original. Same size as Girling tin originally fitted to Mk.V. (Bleed tube not supplied on instruction of Dunlop.)	£16.50
T. 26	C.996	PLIERS - original second-hand	£11.20
T. 28	C.34	SHORT TOMMY-BAR	£12.55
T. 36	C.1002	SCREWDRIVER for distributor for setting points. (Remade with permission of Lucas and approved by them.)	£9.95
T. 41	C1001	TYRE LEVERS - original, used	£19.50 pair
T. 42	C.30	LONG TOMMY-BAR	£17.25



Terms & Conditions

USED PARTS

Although as good a description as possible will be given of the second-hand items, everyone's idea of condition varies. If there is a known or obvious fault with the part, then the prospective customer will be made aware of it. **However, if we supply any second-hand part, be it a single item or a mechanical or mechanised part, or any item that consists of component parts, which is later found to be faulty, unfortunately we would be unable to offer a refund or a replacement part. By the very essence of their nature, second-hand parts are always an unknown quantity, and no guarantee can be given to their condition. It is at the owner's risk that such items are purchased.**

DISCOUNTS

We regret that we cannot give discounts, however large the order or regular the custom. We feel it is fairer to price the parts as competitively as possible to give a fair deal to all our customers, some of whom prefer to order all the parts they need at one time, whilst others prefer to order over a period of time.

LIABILITY

Liability extends only to replacement free of charge, or a refund, in respect of items incorrectly supplied or found to be faulty (not including second-hand items), and notification must be received within 14 days of despatch of goods, so please check your order as soon as you receive it. We regret we cannot give refunds on parts correctly supplied but no longer required.

Please be aware that it is not uncommon for a car to have been fitted with non-standard parts at some stage, so if the new part you receive is not the same as the part on your car, do not automatically assume the new part is wrong. Let us know if you have a problem and we will try to sort it out.

POSTAGE

We aim to send most parcels out using a **tracked service** as this makes for a more secure service, tracking numbers are provided to customers on request.

For small or medium sized parcels sent within the UK we use Royal Mail's tracked 24 hour service.

For larger parcels, and parcels being sent abroad, we use TNT, DHL, Fedex and UPS via the broker World Options.

If a customer specifically requests a next day service this can be investigated, and we are also happy to facilitate customers who wish to arrange their own carrier.